

Suri Vidyasagar College
Department of Computer Science
Sem-6 Study Material
Paper: Computer Networks

TOPIC: Transmission Mediums

Data is represented by computers and other telecommunication devices using signals. Signals are transmitted in the form of electromagnetic energy from one device to another. Electromagnetic signals travel through vacuum, air or other transmission mediums to travel between one point to another(from source to receiver).

Electromagnetic energy (includes electrical and magnetic fields) includes power, voice, visible light, radio waves, ultraviolet light, gamma rays etc.

Transmission medium is the means through which we send our data from one place to another. The first layer (physical layer) of Communication Networks OSI Seven layer model is dedicated to the transmission media.

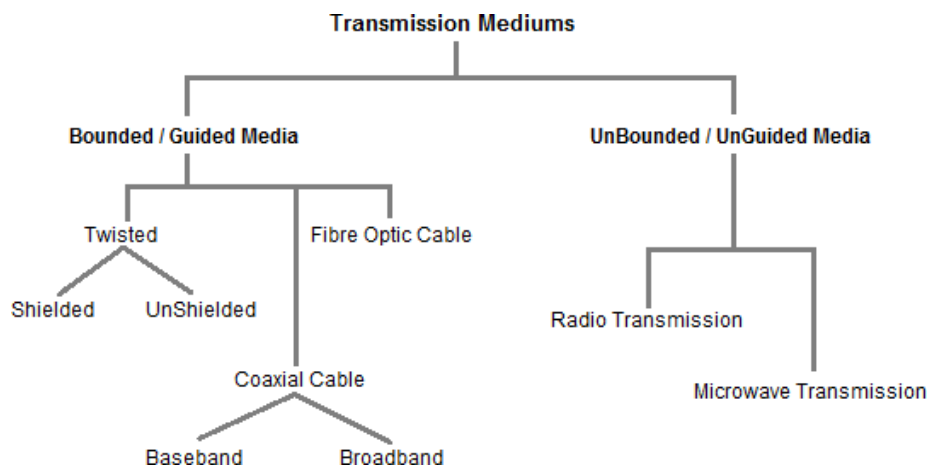

Factors to be considered while choosing Transmission Medium

1. Transmission Rate
 2. Cost and Ease of Installation
 3. Resistance to Environmental Conditions
 4. Distances
-

Bounded/Guided Transmission Media

It is the transmission media in which signals are confined to a specific path using wire or cable. The types of Bounded/ Guided are discussed below.

Twisted Pair Cable

This cable is the most commonly used and is cheaper than others. It is lightweight, cheap, can be installed easily, and they support many different types of network. Some important points :

- Its frequency range is 0 to 3.5 kHz.
- Typical attenuation is 0.2 dB/Km @ 1kHz.
- Typical delay is 50 μ s/km.
- Repeater spacing is 2km.

Twisted Pair is of two types :

- **Unshielded Twisted Pair (UTP)**
- **Shielded Twisted Pair (STP)**

Unshielded Twisted Pair Cable

It is the most common type of telecommunication when compared with Shielded Twisted Pair Cable which consists of two conductors usually copper, each with its own colour plastic insulator. Identification is the reason behind coloured plastic insulation.

UTP cables consist of 2 or 4 pairs of twisted cable. Cable with 2 pair use **RJ-11** connector and 4 pair cable use **RJ-45** connector.

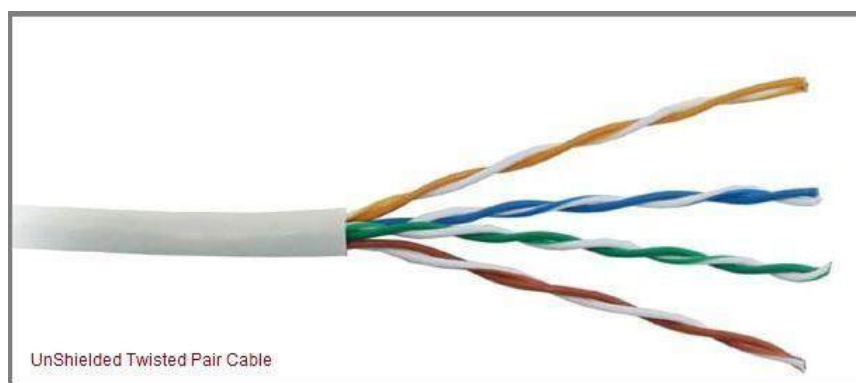

Advantages :

- Installation is easy
- Flexible

- Cheap
- It has high speed capacity,
- 100 meter limit
- Higher grades of UTP are used in LAN technologies like Ethernet.

It consists of two insulating copper wires (1mm thick). The wires are twisted together in a helical form to reduce electrical interference from similar pair.

Disadvantages :

- Bandwidth is low when compared with Coaxial Cable
 - Provides less protection from interference.
-

Shielded Twisted Pair Cable

This cable has a metal foil or braided-mesh covering which encases each pair of insulated conductors. Electromagnetic noise penetration is prevented by metal casing. Shielding also eliminates crosstalk (explained in KEY TERMS Chapter).

It has same attenuation as unshielded twisted pair. It is faster the unshielded and coaxial cable. It is more expensive than coaxial and unshielded twisted pair.

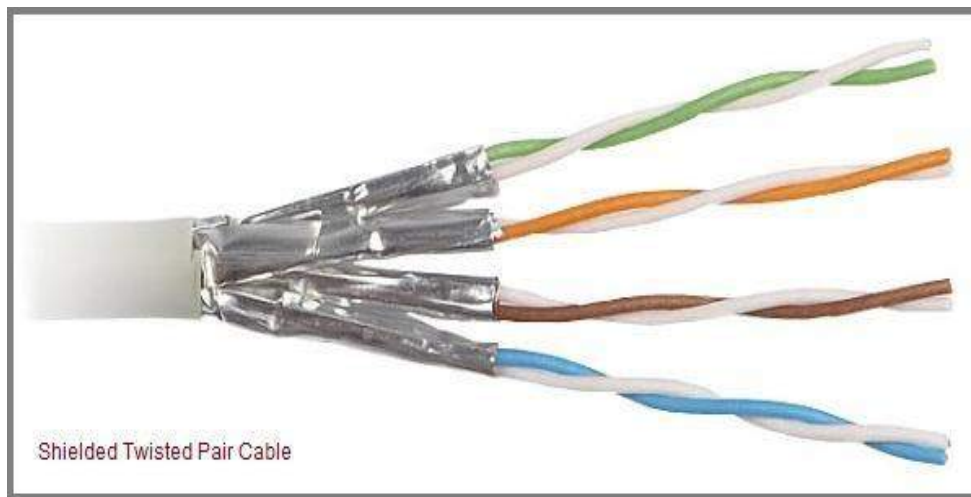

Advantages :

- Easy to install
- Performance is adequate
- Can be used for Analog or Digital transmission

- Increases the signalling rate
- Higher capacity than unshielded twisted pair
- Eliminates crosstalk

Disadvantages :

- Difficult to manufacture
- Heavy

Coaxial Cable

Coaxial is called by this name because it contains two conductors that are parallel to each other. Copper is used in this as centre conductor which can be a solid wire or a standard one. It is surrounded by PVC installation, a sheath which is encased in an outer conductor of metal foil, barid or both.

Outer metallic wrapping is used as a shield against noise and as the second conductor which completes the circuit. The outer conductor is also encased in an insulating sheath. The outermost part is the plastic cover which protects the whole cable.

Here the most common coaxial standards.

- 50-Ohm RG-7 or RG-11 : used with thick Ethernet.
- 50-Ohm RG-58 : used with thin Ethernet
- 75-Ohm RG-59 : used with cable television
- 93-Ohm RG-62 : used with ARCNET.

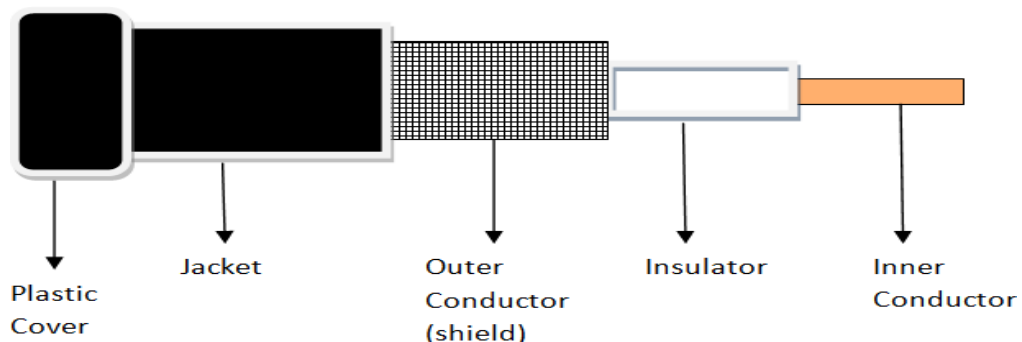

There are two types of Coaxial cables :

BaseBand

This is a 50 ohm (Ω) coaxial cable which is used for digital transmission. It is mostly used for LAN's. Baseband transmits a single signal at a time with very high speed. The major drawback is that it needs amplification after every 1000 feet.

BroadBand

This uses analog transmission on standard cable television cabling. It transmits several simultaneous signal using different frequencies. It covers large area when compared with Baseband Coaxial Cable.

Advantages :

- Bandwidth is high
- Used in long distance telephone lines.
- Transmits digital signals at a very high rate of 10Mbps.
- Much higher noise immunity
- Data transmission without distortion.
- They can span to longer distance at higher speeds as they have better shielding when compared to twisted pair cable

Disadvantages :

- Single cable failure can fail the entire network.
- Difficult to install and expensive when compared with twisted pair.
- If the shield is imperfect, it can lead to grounded loop.

Fiber Optic Cable

These are similar to coaxial cable. It uses electric signals to transmit data. At the centre is the glass core through which light propagates.

In multimode fibres, the core is 50microns, and In single mode fibres, the thickness is 8 to 10 microns.

The core in fiber optic cable is surrounded by glass cladding with lower index of refraction as compared to core to keep all the light in core. This is covered with a thin plastic jacket to protect the cladding. The fibers are grouped together in bundles protected by an outer shield.

Fiber optic cable has bandwidth more than **2 gbps (Gigabytes per Second)**

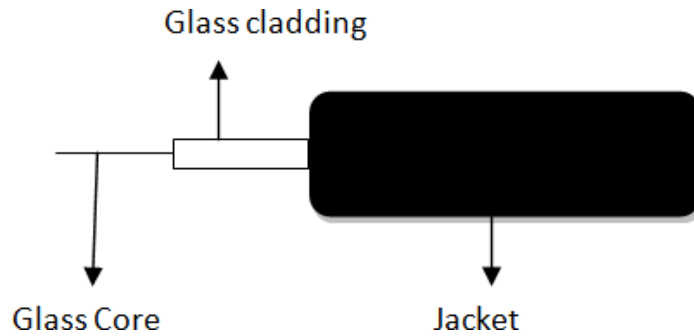

Advantages :

- Provides high quality transmission of signals at very high speed.
- These are not affected by electromagnetic interference, so noise and distortion is very less.
- Used for both analog and digital signals.

Disadvantages :

- It is expensive
- Difficult to install.
- Maintenance is expensive and difficult.
- Do not allow complete routing of light signals.

UnBounded/UnGuided Transmission Media

Unguided or wireless media sends the data through air (or water), which is available to anyone who has a device capable of receiving them. Types of unguided/ unbounded media are discussed below :

- Radio Transmission
 - MicroWave Transmission
-

Radio Transmission

Its frequency is between 10 kHz to 1GHz. It is simple to install and has high attenuation. These waves are used for multicast communications.

Types of Propagation

Radio Transmission utilizes different types of propagation :

- **Troposphere** : The lowest portion of earth's atmosphere extending outward approximately 30 miles from the earth's surface. Clouds, jet planes, wind is found here.
 - **Ionosphere** : The layer of the atmosphere above troposphere, but below space. Contains electrically charged particles.
-

Microwave Transmission

It travels at high frequency than the radio waves. It requires the sender to be inside of the receiver. It operates in a system with a low gigahertz range. It is mostly used for unicast communication.

There are 2 types of Microwave Transmission :

1. Terrestrial Microwave
2. Satellite Microwave

Advantages of Microwave Transmission

- Used for long distance telephone communication
- Carries 1000's of voice channels at the same time

Disadvantages of Microwave Transmission

- It is Very costly
-

Terrestrial Microwave

For increasing the distance served by terrestrial microwave, repeaters can be installed with each antenna. The signal received by an antenna can be converted into transmittable form and relayed to next antenna as shown in below figure. It is an example of telephone systems all over the world

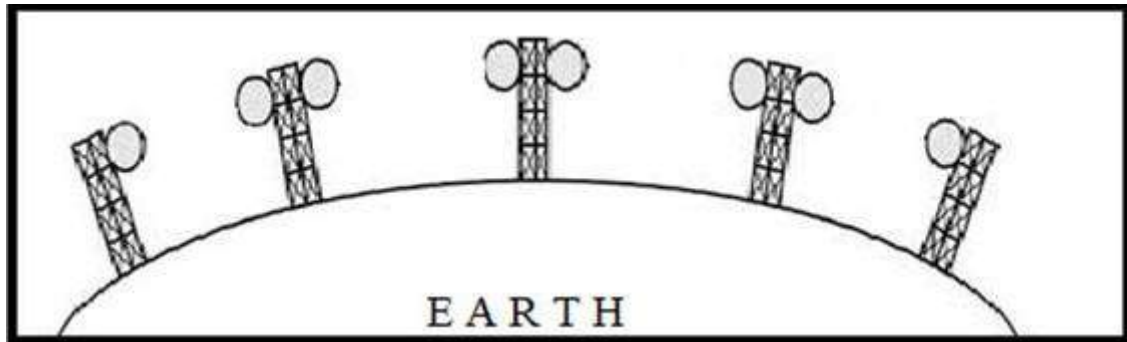

There are two types of antennas used for terrestrial microwave communication :

1. Parabolic Dish Antenna

In this every line parallel to the line of symmetry reflects off the curve at angles in a way that they intersect at a common point called focus. This antenna is based on geometry of parabola.

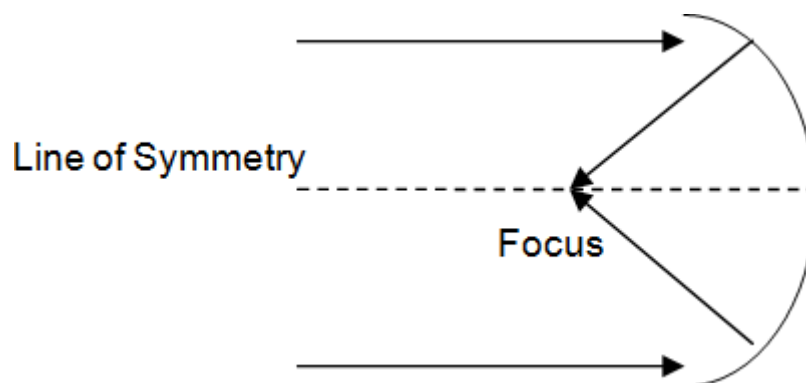

2. Horn Antenna

It is a like gigantic scoop. The outgoing transmissions are broadcast up a stem and deflected outward in a series of narrow parallel beams by curved head.

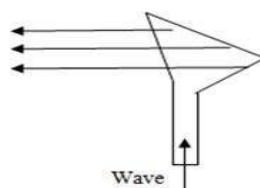

Satellite Microwave

This is a microwave relay station which is placed in outer space. The satellites are launched either by rockets or space shuttles carry them.

These are positioned 3600KM above the equator with an orbit speed that exactly matches the rotation speed of the earth. As the satellite is positioned in a geo-synchronous orbit, it is stationary relative to earth and always stays over the same point on the ground. This is usually done to allow ground stations to aim antenna at a fixed point in the sky.

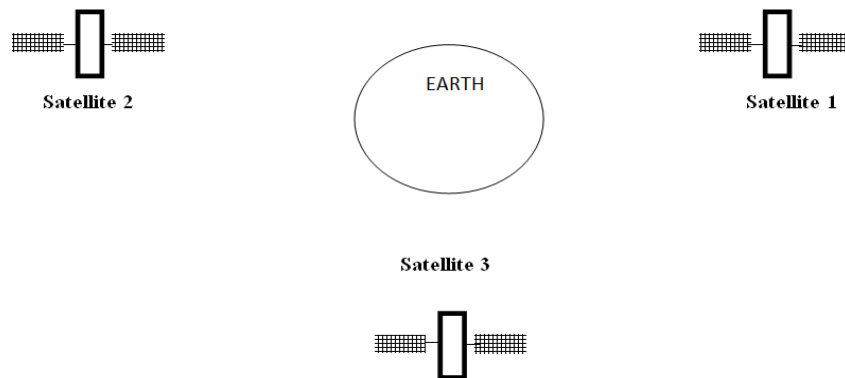

Features of Satellite Microwave :

- Bandwidth capacity depends on the frequency used.
- Satellite microwave deployment for orbiting satellite is difficult.

Advantages of Satellite Microwave :

- Transmitting station can receive back its own transmission and check whether the satellite has transmitted information correctly.
- A single microwave relay station which is visible from any point.

Disadvantages of Satellite Microwave :

- Satellite manufacturing cost is very high
- Cost of launching satellite is very expensive
- Transmission highly depends on whether conditions, it can go down in bad weather